

## SC060N65Y4

### 29 Amps,650 Volts N-Channel Sic Power MOSFET

#### Features

- 29A,650V, $R_{DS(ON)MAX}=79m\ \Omega$  @ $V_{GS}=18V/13.2A$
- High Blocking Voltage with low On-Resistance
- High Speed Switching with Low Capacitance
- Fast Intrinsic Diode with Low Reverse Recovery ( $Q_{rr}$ )

#### Benefits

- Higher System Efficiency
- Reduced Cooling Requirements
- Increased Power Density
- Increased System Switching Frequencytance
- Easy to Parallel and Simple to Drive
- Enable Totem-Pole PFC Topologies

#### Applications

- EV Charging
- Server Power Supplies
- Solar PV Inverters
- UPS
- DC/DC Converters

#### TO-247-4L

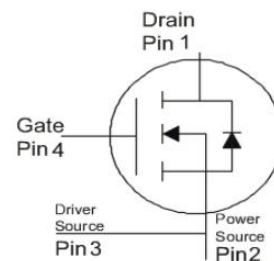
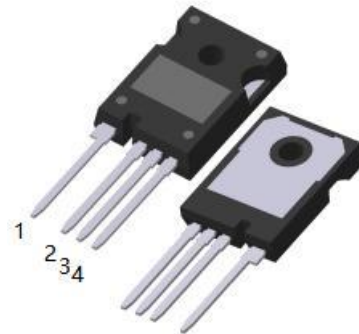

#### Absolute Maximum Ratings( $T_c=25^\circ C$ , unless otherwise noted)

Parameter	Symbol	Value	UNIT	Test Conditions
Drain-Source Voltage	$V_{DSmax}$	650	V	$V_{GS}=0V, I_{DS}=100\mu A$
Gate-Source Voltage(dynamic)	$V_{GSmax}$	-8/+22		Absolute maximum values
Gate-Source Voltage (static)	$V_{GSop}$	-4/+18		Recommended operational values
Continuous Drain Current	$I_D$	29	A	$V_{GS}=18V, T_c=25^\circ C$
		20		$V_{GS}=18V, T_c=100^\circ C$
Pulsed Drain Current	$I_{D(pulse)}$	99	A	Pulse width $t_p$ limited by $T_{Jmax}$
Power Dissipation	$P_D$	150	W	$T_c=25^\circ C, T_J=175^\circ C$
Operating Junction and Storage Temperature Range	$T_J, T_{STG}$	-40 to +175	$^\circ C$	

#### Thermal Characteristics

Parameter	Symbol	SC060N65Y4	Units
Maximum Junction-to-Case	$R_{thJC}$	0.99	$^\circ C/W$

<b>Electrical Characteristics</b> ( $T_c=25^\circ\text{C}$ , unless otherwise noted)						
Parameter	Symbol	Test Conditions	Min	Typ	Max	Units
Drain-Source Breakdown Voltage	$BV_{DSS}$	$V_{GS}=0V, I_D=100\mu A, T_c=25^\circ\text{C}$	650	—	—	V
Zero Gate Voltage Drain Current	$I_{DSS}$	$V_{DS}=650V, V_{GS}=0V$	—	1	50	$\mu\text{A}$
Gate-Body Leakage Current	$I_{GSS}$	$V_{GS}=18V, V_{DS}=0V$	—	10	250	nA
Gate-Source Threshold Voltage	$V_{GS(th)}$	$V_{DS}=V_{GS}, I_D=5\text{mA}$	1.8	2.6	4.0	V
Drain-Source On-State Resistance	$R_{DS(on)}$	$V_{GS}=18V, I_D=13.2\text{A}$	42	60	79	m $\Omega$
		$V_{GS}=18V, I_D=13.2\text{A}, T_J=175^\circ\text{C}$	—	75	—	
Input Capacitance	$C_{iss}$	$V_{DS}=600V, V_{GS}=0V,$ $f=1.0\text{MHz}, V_{AC}=25\text{mV}$	—	830	—	pF
Output Capacitance	$C_{oss}$		—	82	—	pF
Reverse Transfer Capacitance	$C_{rss}$		—	14	—	pF
Turn-On Delay Time	$t_{d(on)}$	$V_{DS}=400V, V_{GS}=-4V/18V,$ $I_D=13.2\text{A}, R_g=2.5\Omega, R_L=30\Omega$	—	8	—	ns
Turn-On Rise Time	$t_r$		—	9	—	ns
Turn-Off Delay Time	$t_{d(off)}$		—	21	—	ns
Turn-Off Fall Time	$t_f$		—	8	—	ns
Turn-On Switching Energy	$E_{ON}$	$V_{DS}=400V, V_{GS}=-4V/18V$	—	140	—	$\mu\text{J}$
Turn-Off Switching Energy	$E_{OFF}$	$I_D=13.2\text{A}, R_g=2.5\Omega, L=200\mu\text{H}$	—	52	—	$\mu\text{J}$
Internal Gate Resistance	$R_G$	$f=1\text{MHz}, V_{AC}=25\text{mV}$	—	6	—	$\Omega$
Total Gate Charge	$Q_g$	$V_{DS}=400V, I_D=13.2\text{A},$ $V_{GS}=-4V/18V$	—	50	—	nC
Gate-Source Charge	$Q_{GS}$		—	13	—	
Gate-Drain Charge	$Q_{gd}$		—	12	—	
<b>Reverse Diode Characteristics</b>						
Diode Forward Voltage	$V_{SD}$	$V_{GS}=-4V, I_{SD}=6.6\text{A}$	—	4.2	—	V
		$V_{GS}=-4V, I_{SD}=6.6\text{A}, T_J=175^\circ\text{C}$	—	3.8	—	
Continuous Diode Forward Current	$I_S$	$V_{GS}=-4V, T_c=25^\circ\text{C}$	—	—	23	A
Reverse Recover Time	$t_{rr}$	$V_R=400V, I_{SD}=13.2\text{A}$	—	28	—	ns
Reverse Recovery Charge	$Q_{rr}$		—	47	—	nc
Peak Reverse Recovery Current	$I_{rrm}$		—	3	—	A

## RATING AND CHARACTERISTIC CURVES

Figure.1 Output Characteristics  $T_j=25^\circ\text{C}$

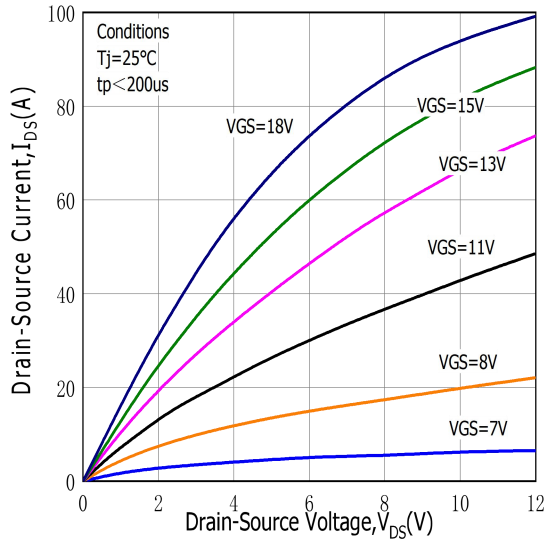

Figure.2 Output Characteristics  $T_j=175^\circ\text{C}$

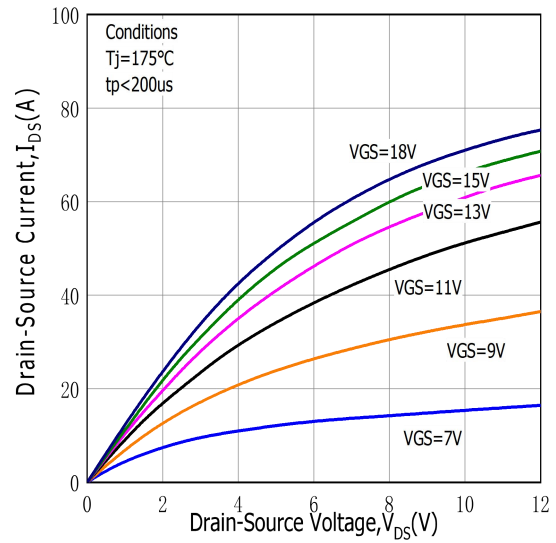

Figure.3 On-Resistance vs. Temperature

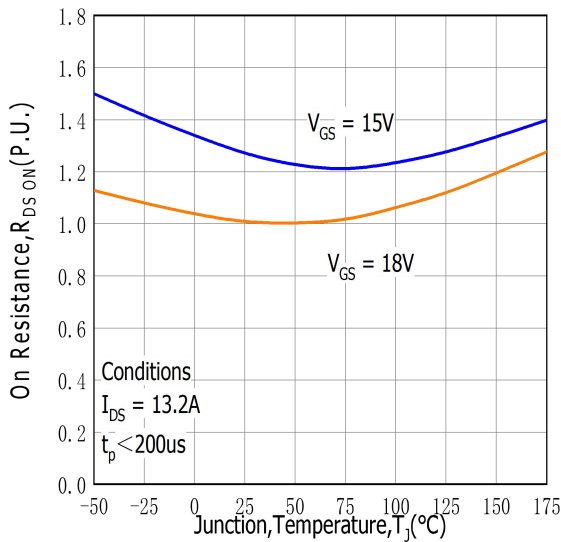

Figure.4 Threshold Voltage vs. Temperature

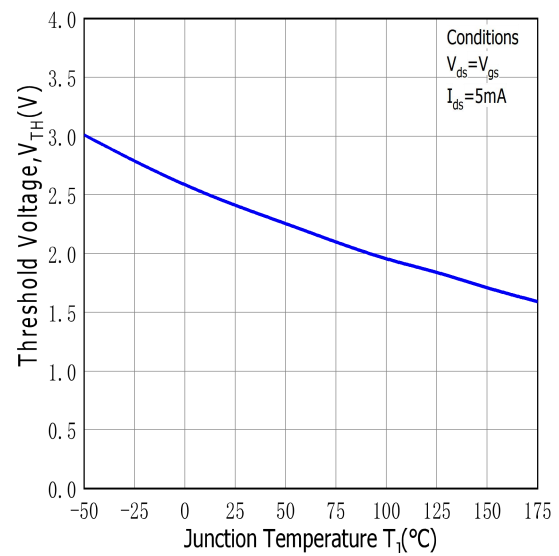

Figure.5 Body Diode Characteristic at  $25^\circ\text{C}$

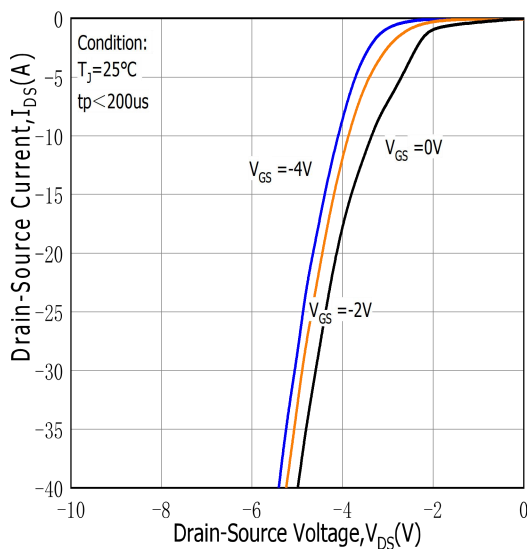

Figure.6 Body Diode Characteristic at  $175^\circ\text{C}$

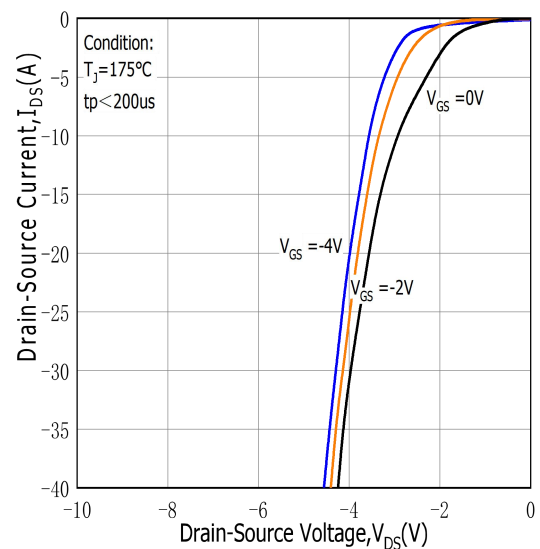

Figure.7 3rd Quadrant Characteristic at 25°C

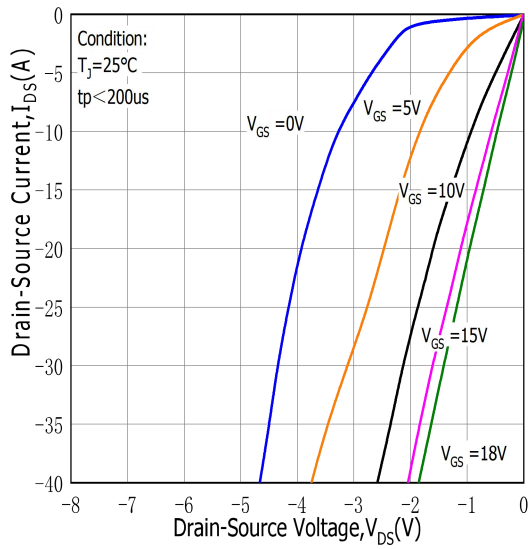

Figure.8 3rd Quadrant Characteristic at 175°C

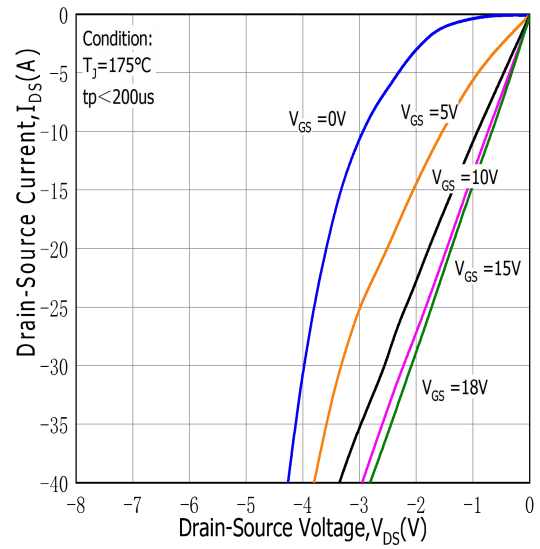

Figure.9 Capacitances vs. Drain-Source Voltage(0-200V)

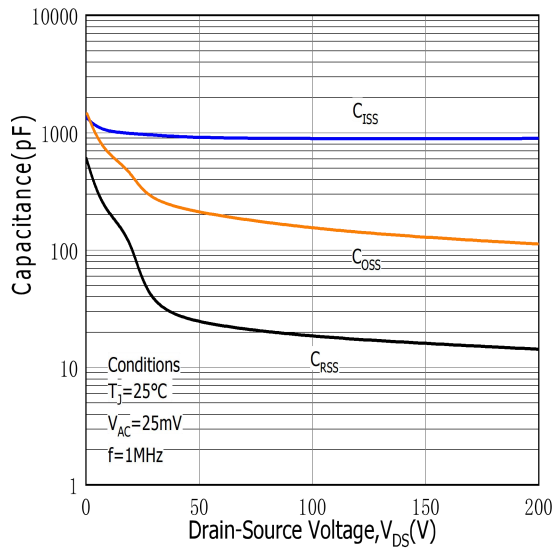
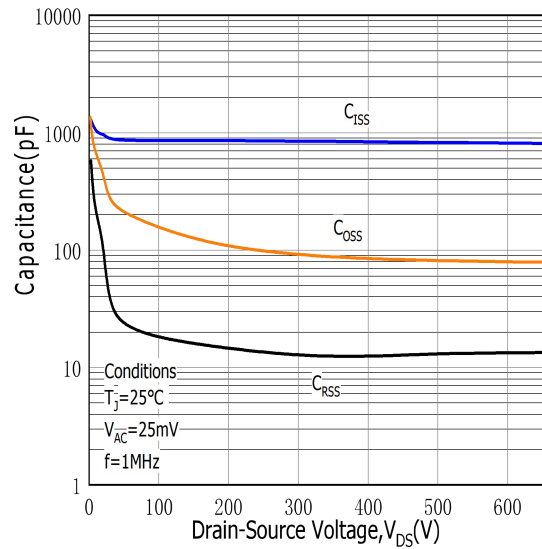
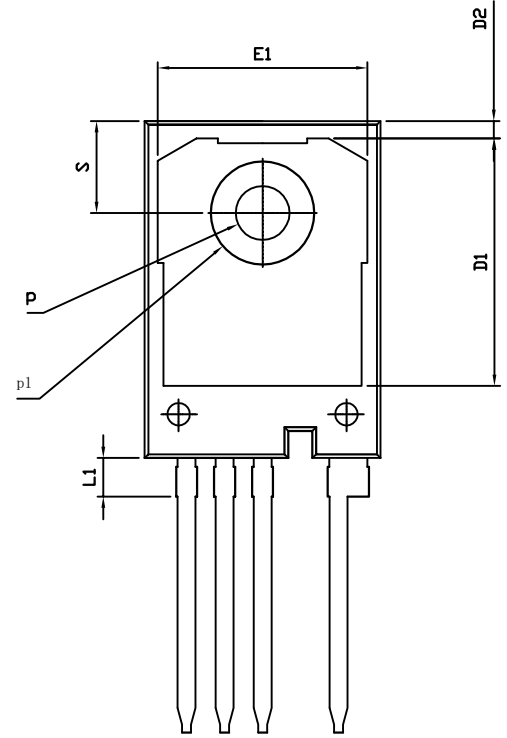
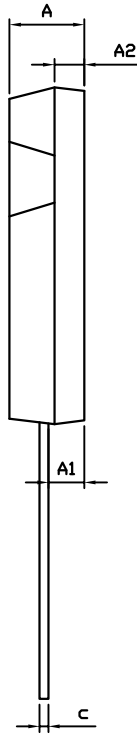
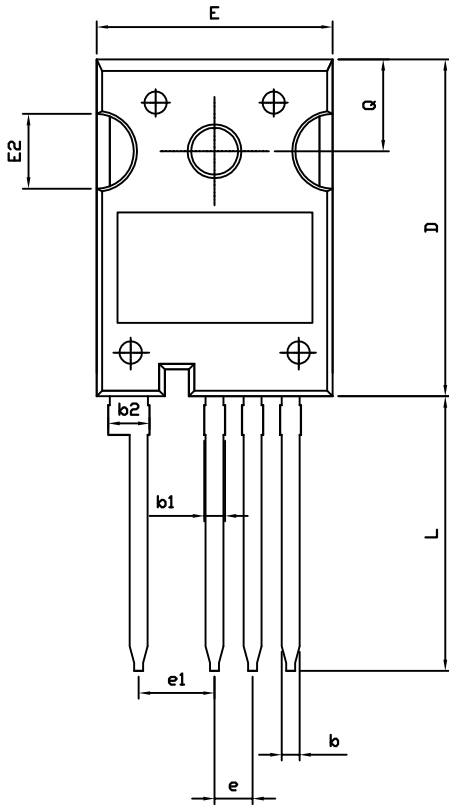

Figure.10 Capacitances vs. Drain-Source Voltage(0-650V)



# TO-247-4L PACKAGE OUTLINE



## RECOMMENDED LAND PATTERN

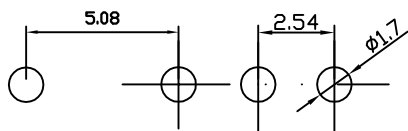

UNIT: mm

	MIN	NOM	MAX
A	4.80	5.00	5.20
A1	2.25	2.40	2.45
A2	1.85	2.00	2.15
b	1.05	1.20	1.35
b1	1.00	1.30	1.60
b2	2.35	2.65	2.95
c	0.50	0.60	0.70
D	22.34	22.54	22.74
D1	16.00	16.50	17.00
D2	0.97	1.17	1.37
e	2.34	2.54	2.74
e1	4.88	5.08	5.28
E	15.60	15.80	16.00
E1	13.50	14.00	14.50
E2	4.80	5.00	5.20
L	18.08	18.38	18.68
L1	2.38	2.58	2.78
p	3.50	3.60	3.70
p1	6.60	6.80	7.00
Q	6.00	6.15	6.30
S	6.00	6.15	6.30